



User Guide

AV600 2-port Passthrough
Powerline Adapter
TL-PA4020P

Contents

About This Guide	1
Chapter 1. Get to Know Your Powerline Adapter	2
1.1. Product Overview.....	3
1.2. Product Appearance.....	3
Chapter 2. Use Your Powerline Adapter.....	5
2.1. Before You Start	6
2.2. Extend Your Wired Network by Plug & Play	7
2.3. Secure Your Powerline Network by Pairing.....	8
2.4. Add Another Powerline Adapter.....	9
2.5. Manage Your Powerline Network via tpPLC Utility.....	10
FAQ (Frequently Asked Questions)	11

About This Guide

This guide is a complement to Quick Installation Guide. The Quick Installation Guide provides instructions for quick Internet setup, while this guide contains details of each function and demonstrates how to configure them in typical scenarios.

When using this guide, please notice that features of the powerline adapter may vary slightly depending on the model and software version you have, and on your location, and language. All images, parameters and descriptions documented in this guide are used for demonstration only.

Conventions

In this guide, the following conventions are used:

Convention	Description
<u>Teal Underlined</u>	Hyperlinks are in teal and underlined. You can click to redirect to a website or a specific section.
Teal	Key information appears in teal, including management page text such as menus, items, buttons and so on.
■ Note:	Ignoring this type of note might result in a malfunction or damage to the device.
📌 Tips:	Indicates important information that helps you make better use of your device.

More Info

- The latest software, management app and utility are available from the [Download Center](http://www.tp-link.com/support) at <http://www.tp-link.com/support>.
- The Quick Installation Guide (QIG) can be found where you find this guide or inside the product package.
- Specifications can be found on the product page at <http://www.tp-link.com>.
- A Technical Support Forum is provided for you to discuss our products at <http://forum.tp-link.com>.
- Our Technical Support contact information can be found at the [Contact Technical Support](http://www.tp-link.com/support) page at <http://www.tp-link.com/support>.

Chapter 1

Get to Know Your Powerline Adapter

This chapter introduces what the powerline adapter can do and describes its appearance.

It contains the following sections:

- [Product Overview](#)
- [Product Appearance](#)

1.1. Product Overview

TP-Link powerline adapter aims to extend your existing home network, with the help of your home's electrical circuit.

The integrated power socket on the powerline adapter provides an outlet for other electronic devices. Its built-in noise filter eliminates electrical signal noise and therefore guarantees the high quality transmission of data via powerline.

1.2. Product Appearance

Your powerline adapter may differ in appearance slightly from that depicted because of the region and product version.

1.2.1. LED Legend

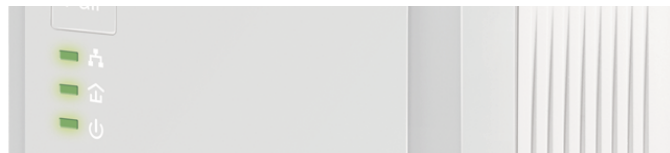

LEDs indicate the powerline adapter's working status. For more details, please refer to the following table.

Name	Status	Indication
⏻ Power	On/Off	The powerline adapter is on or off.
	Blinking	Once every second: Pairing is taking place.
		Once every 15 seconds: Power-Saving Mode* is on.
🏠 Powerline	On	The powerline adapter is connected to a powerline network.
	Off	The powerline adapter is not connected to any powerline network or is in Power-Saving Mode.
🌐 Ethernet	On	The Ethernet port is connected.
	Off	The Ethernet port is not connected.

* If the device connected to the adapter is turned off or inactive for more than 5 minutes, the powerline adapter will automatically switch to Power-Saving Mode.

1.2.2. Physical Interface

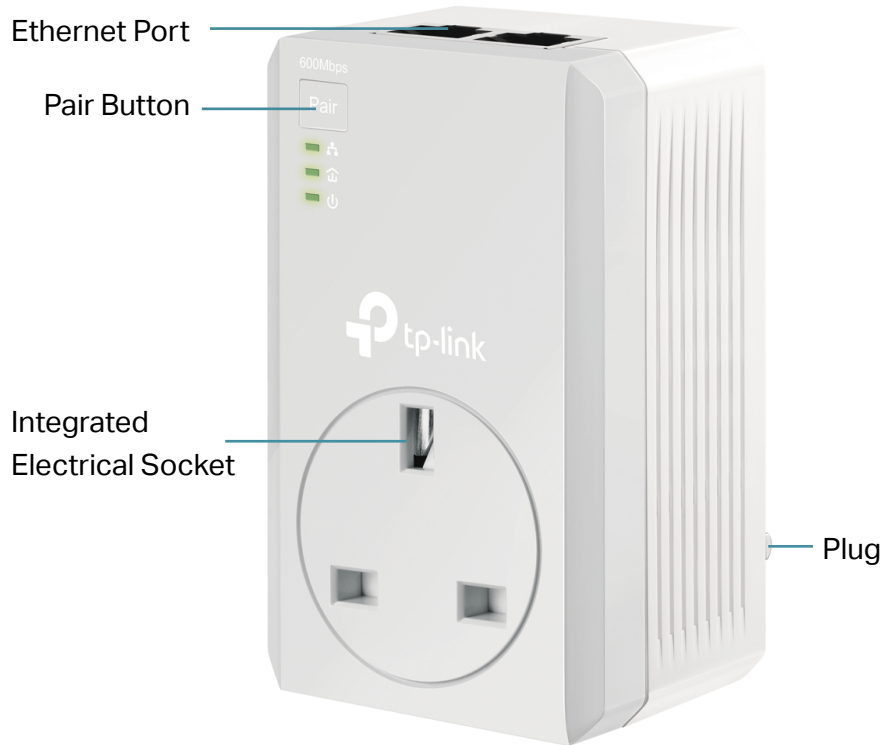

Ethernet Port

Connect the Ethernet port to your wired device, such as a computer, a router or a game console, via an Ethernet cable.

Pair Button

Press and hold the button for 1 second to join a powerline network. Go to [Secure Your Powerline Network by Pairing](#) for more information.

Press and hold the button for about 8 seconds to leave the existing powerline network.

Press and hold the button for more than 15 seconds to reset the powerline adapter to factory defaults.

Power Plug

The powerline adapter has a Plug that can be connected to a (100V-240V~, 50/60Hz) power socket.

Integrated Electrical Socket

The integrated electrical socket is a pass-through AC outlet used to power other electronic devices. Its built-in noise filter reduces electrical noise and therefore guarantees performance.

Chapter 2

Use Your Powerline Adapter

This chapter guides you on how to use the powerline adapter.

It contains the following sections:

- [Before You Start](#)
- [Extend Your Wired Network by Plug & Play](#)
- [Secure Your Powerline Network by Pairing](#)
- [Add Another Powerline Adapter](#)
- [Manage Your Powerline Network via tpPLC Utility](#)

2.1. Before You Start

Powerline adapters work in pairs. You should have at least two powerline products to build a powerline network. To optimize your network performance, please follow these principles:

- All powerline adapters should be on the same electrical wiring system.
- Avoid plugging in powerline adapters and high-powered household devices (such as washing machines and refrigerators) close to one another.
- Plug the powerline adapter directly into a wall outlet. Do not plug the powerline adapter into a power strip, extension cord, or surge protector.

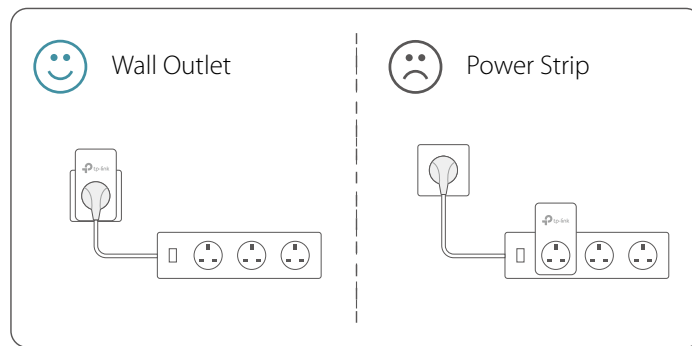

- Use the powerline adapter only in below directions.

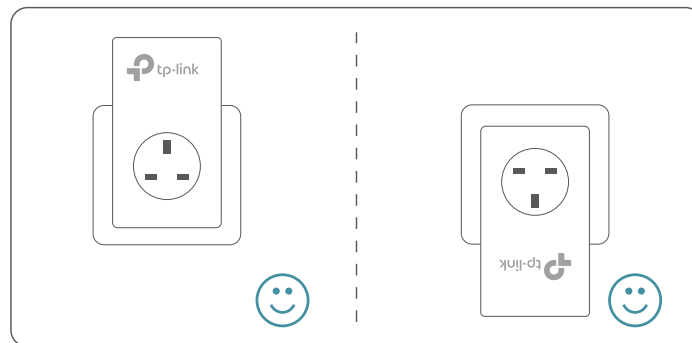

2.2. Extend Your Wired Network by Plug & Play

I want to:

Use two powerline adapters to set up a new powerline network in my house.

For example, I have a router in my house, but there are not enough LAN ports for all my wired devices. I don't want complex and expensive cabling. People told me that I can solve this problem with two powerline adapters.

How can I do that?

1. Connect one of the powerline adapters to an available LAN port of the router using an Ethernet cable.
2. Plug the powerline adapter into a wall outlet.
3. Plug the other powerline adapter into a wall outlet on the same electrical circuit at the place you want Internet. Wait until the powerline LED  turns on.
Note: If the Powerline LED does not turn on, reset each powerline adapter to its factory default settings. Refer to [How do I reset my powerline adapter?](#) for detailed information.
4. Connect your wired device, such as a computer or game console, to the powerline adapter via an Ethernet cable.

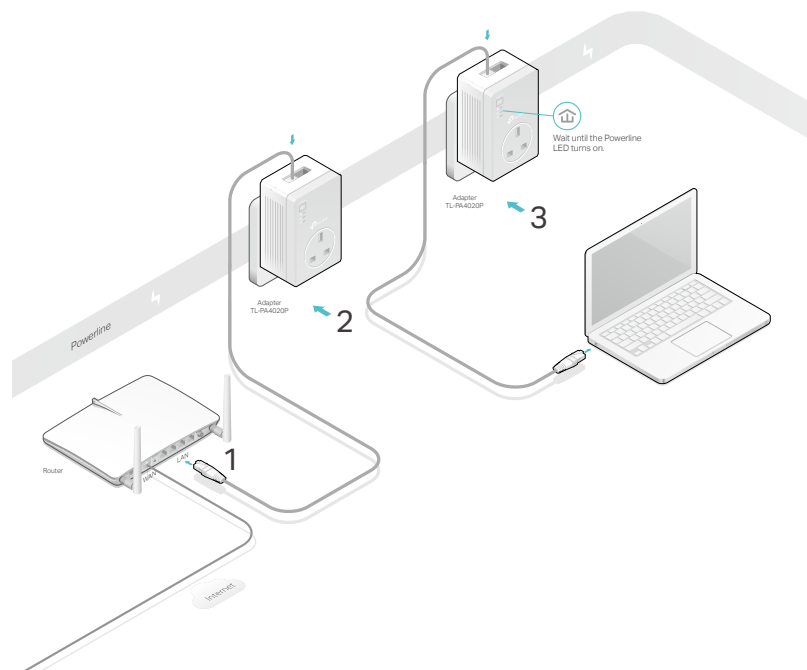

Done!

Now enjoy the Internet!

2.3. Secure Your Powerline Network by Pairing





All powerline adapters share some common factory settings, and can communicate with one another. If you want your powerline adapters to communicate only with your own powerline adapters, you should pair them. Thus a secured powerline network is formed and other powerline adapters can no longer join your powerline network without being paired.

Note: You can only pair two devices at a time.

I want to: Secure my powerline network and prevent other powerline devices from being added to my network.

For example, I've extended my network using the Plug & Play method. Now I want to secure my network.

How can I do that?

1. Verify all powerline devices' Power LEDs  are solid on.
 - Tips:** We recommend that you plug in your powerline devices next to each other, or as close to each other as possible when pairing. Your settings will not be affected. The devices can be relocated to where they are needed once pairing is complete.
2. Press the Pair button on one of the powerline devices for 1 second. Its Power LED  starts blinking.
3. Within two minutes, press the Pair button on another powerline adapter for 1 second. Its Power LED  starts blinking. When the Powerline LED  stays on, the pairing process is complete.

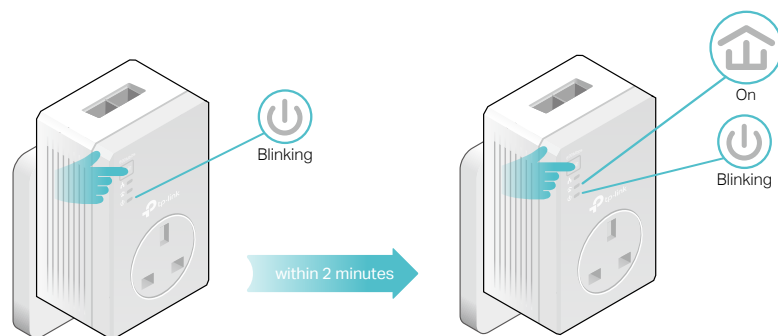

Done!

Enjoy your secure powerline network!

2.4. Add Another Powerline Adapter





I want to: Add a new powerline adapter into the existing powerline network to extend my network.

For example, I've already set up a powerline network using powerline devices, but the network does not reach everywhere I need it to. I purchased another one to further extend my network.

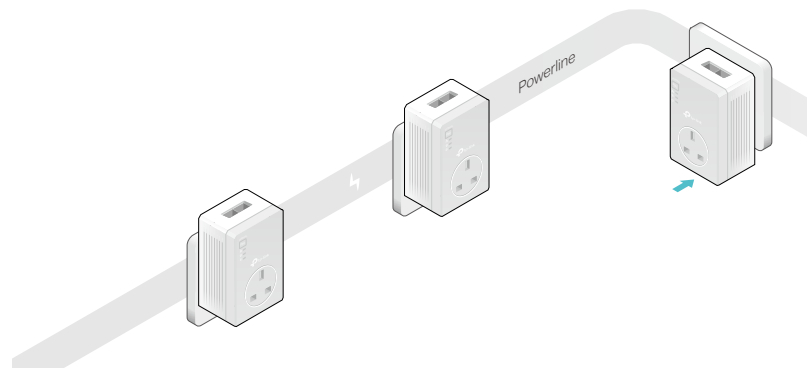
How can I do that?

1. Plug the new powerline adapter into a wall outlet near one of the existing powerline devices.



2. Wait for a minute, and check whether the Powerline LED  stays on. If it's on, skip to step 3. If it's not, continue with step 2 to pair the new powerline adapter into the secured powerline network.
 - a. Press the Pair button on one of the existing powerline devices for 1 second. Its Power LED  starts blinking.
 - b. Within two minutes, press the Pair button on the new powerline adapter for 1 second. Its Power LED  starts blinking. When the Powerline LED  stays on and solid, the pairing process is complete.

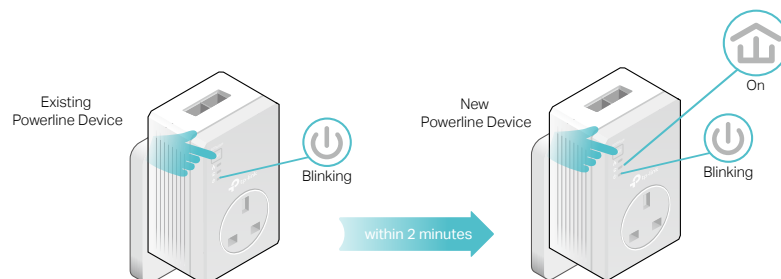

3. Relocate the new powerline adapter to the place where wired Internet access is needed.

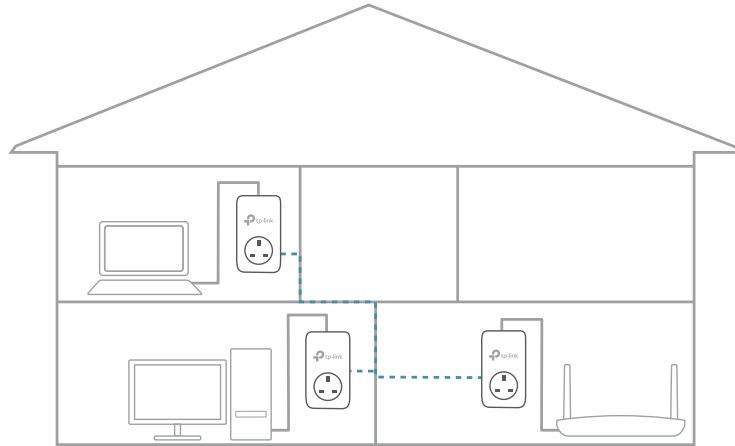

Done!

Enjoy the Internet through your extended network!

2.5. Manage Your Powerline Network via tpPLC Utility

The tpPLC utility enables you to view and manage your TP-Link powerline network. Its bold and intuitive interface helps you easily configure each powerline device.

You can find the utility and its user guide on the product support page at <http://www.tp-link.com>.

FAQ (Frequently Asked Questions)

Q1. How do I reset my powerline adapter?

With the powerline adapter plugged into the wall socket, press and hold its Pair button for more than 15 seconds until the Power LED  goes off momentarily and comes back on.

Q2. How to troubleshoot if there is no Internet connection via my powerline network?

- Make sure all powerline devices are on the same electrical circuit.
- Make sure the Powerline LEDs  are lit on all of your powerline devices. If they are not, pair all powerline devices according to [Secure Your Powerline Network by Pairing](#).
- Make sure all devices are correctly and securely connected.
- Verify that you have an Internet connection by connecting your computer directly to the modem or the router.

Q3. What can I do if a successfully-paired powerline device does not reconnect after it has been moved to a new location ?

- Try another socket on the same electrical circuit.
- Try to pair it again, and make sure the Powerline LED  is on.
- Check for possible interference due to washing machines, air conditioners or other household appliances. Some powerline devices have an integrated electrical socket. You can plug appliances into this socket to remove the electrical noise originating from them, using a power strip if necessary.

COPYRIGHT & TRADEMARKS

Specifications are subject to change without notice.  tp-link is a registered trademark of TP-Link Technologies Co., Ltd. Other brands and product names are trademarks or registered trademarks of their respective holders.

No part of the specifications may be reproduced in any form or by any means or used to make any derivative such as translation, transformation, or adaptation without permission from TP-Link Technologies Co., Ltd. Copyright © 2017 TP-Link Technologies Co., Ltd. All rights reserved.

CE Mark Warning



This is a class B product. In a domestic environment, this product may cause radio interference, in which case the user may be required to take adequate measures.



Продукт сертифіковано згідно с правилами системи УкрСЕПРО на відповідність вимогам нормативних документів та вимогам, що передбачені чинними законодавчими актами України.



Safety Information

- When product has power button, the power button is one of the way to shut off the product; when there is no power button, the only way to completely shut off power is to disconnect the product or the power adapter from the power source.
- Don't disassemble the product, or make repairs yourself. You run the risk of electric shock and voiding the limited warranty. If you need service, please contact us.
- Avoid water and wet locations.

Explanation of the symbols on the product label

Symbol	Explanation
	AC voltage
	Indoor use only
	RECYCLING This product bears the selective sorting symbol for Waste electrical and electronic equipment (WEEE). This means that this product must be handled pursuant to European directive 2012/19/EU in order to be recycled or dismantled to minimize its impact on the environment. User has the choice to give his product to a competent recycling organization or to the retailer when he buys a new electrical or electronic equipment.
	Protection earth